

CONFIGURATION – B (Not Recommended)

For best results, use Configuration – A only

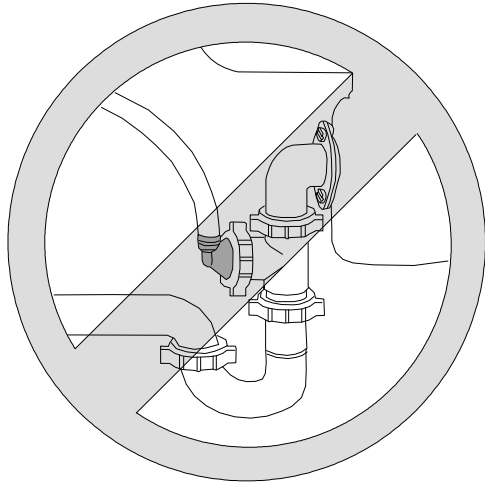

CONFIGURATION-B

CAUTION: Be careful not to “overtighten” any screw on plastic fittings.

NOTE: To connect a reverse osmosis reject water drain line to the plumbing of a single compartment sink without disposal, or a double compartment sink, please request a ET112-001.

Drain saddles are a prohibited fitting in the United States.

The ET109-001 is designed to be used downstream of an approved airgap.

Serving the
Reverse Osmosis
Water Treatment Industry

AIR GAP

MADE IN USA
ASTM F 409



Copyright 2017 AIR GAP INTERNATIONAL

Model: ET109-001 (DLA-9TM)

Pat. No. 5,449,456
Pat. No. 5,681,459
Pat. No. 5,944,985
Pat. No. 6,193,879

MADE IN USA

Reverse Osmosis DRAIN LINE ADAPTER

► For Single Compartment
Sink with Disposal



ASTM F 409

Part No.
ET109-00
1
(9-25QC)

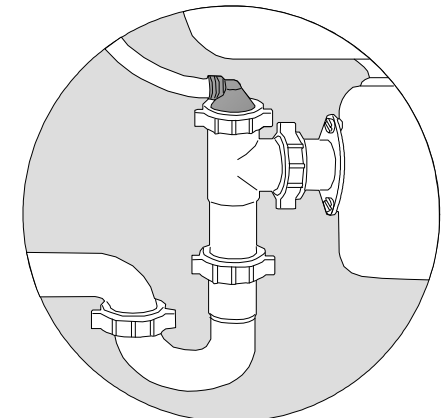





ET109-001

Installation Procedures

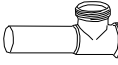
For Single Compartment Sink with Disposal

LIST OF PARTS ENCLOSED

1 – Drain Line Adapter with Push-In Connection (ET109-001/ET112-001)...	
1 – Disposal (Baffle) Tee.....	
1 – Flanged Tailpiece.....	
2 – Slip Joint (S.J.) Wing Nuts.....	
2 – Slip Joint (S.J.) Beveled Washers.....	

- **The ET109-001 converts the plumbing of a single sink / disposal installation to receive the reject water from an under-counter reverse osmosis appliance.**
- **To install the ET109-001 reverse osmosis reject water Drain Line Adapter, follow these instructions.**

Please read the instructions once through before starting.

CONFIGURATION – A (Recommended)

1. Remove disposal ell and J-bend from disposal and trap. Use bowl to catch trap water. (See Fig. 1)

2. Cut new flanged tailpiece (provided) leaving approximately 1 ½ - 2" from flange, so that when positioned between disposal and disposal tee (provided), the tailpiece of the tee will line up and insert into J-bend of trap. (See Figs. 2a & 2c)

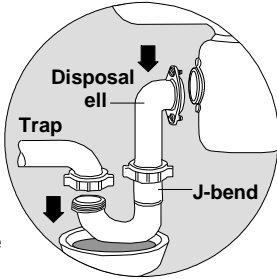

FIG. 1

Always ensure that tube ends are cut squarely and inserted into bottom of all slip joint (S.J.) sockets.

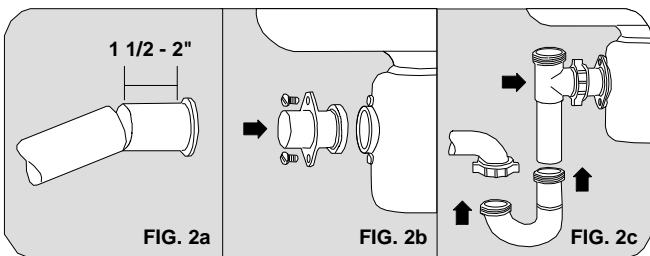

FIG. 2a

FIG. 2b

FIG. 2c

NOTE: in some cases, it may be necessary to rotate the disposal and J-bend in order to gain the distance required to line up the new disposal tee. To do this, loosen the disposal locking ring, rotate disposal as desired, then tighten.

3. Reuse rubber gasket from disposal ell by mounting on flange of new tailpiece. (See Fig. 2b)

4. Insert new drain line adapter with push-in connector (provided) into top of disposal tee until it firmly seats on bottom of socket. Gently secure with S.J. washer and wing nut (provided). (See Fig. 3)

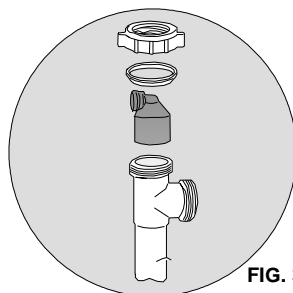

FIG. 3

5. Mount gasket end of cut tailpiece to disposal in reverse order that disposal ell was removed (See Fig. 2b).

Then install side outlet of disposal tee securely onto cut end of tailpiece with S.J. washer and wing nut (provided). (See Fig. 2c)

6. Replace J-bend by sliding onto trap and tailpiece of disposal tee simultaneously. Secure tightly by reusing original S.J. nuts and washer. (See Fig. 2c & 4)

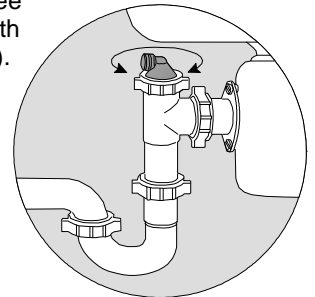

FIG. 4

7. Rotate push-in connector towards incoming reject water drain tubing and secure tightly with wing nut. (See Fig. 4)

8. Insert drain tubing into push-in connector to complete the installation. (See Fig. 5)

IMPORTANT:

- Use only high quality ¼" O.D. tubing of exact size and roundness with no surface nicks or scratches.
- Always make a clean square cut if necessary, using a plastic tubing cutter or sharp razor knife.

CAUTION:

- To assure a leak free connection, tubing must seat fully into bottom of socket. (If there is any doubt, measure 7/16" from end of tube and insert measured length until stop is felt.)
- Check that connection is leak free.

FIG. 5
Speed Fit/Push-in Connector

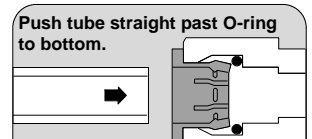

FIG. 5a

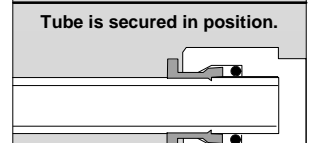

FIG. 5b

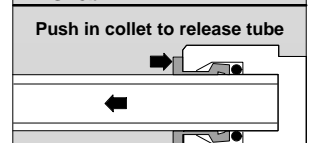

FIG. 5c