

9. Connect a 3-inch long 5/8-inch hose to the inlet port using clamps to connect tubing from a dishwasher. Clamp the other end to the tubing from the dishwasher. (See Fig.4)

10. Connect the air gap outlet to the garbage disposal drain inlet using a 7/8-inch dishwasher drain line hose and two hose clamps.

IMPORTANT:
Remove the garbage disposal knock-out plug if still present. Tap away all edges until a round hole remains. Disconnect power to the garbage disposal unit and then remove the plug inside the disposal. Run fingers around the bottom of the disposal chamber to locate fragments. (See CAUTION below)

CAUTION: Exercise extreme caution whenever reaching hand inside the garbage disposal. After confirming that power has been turned off (and will stay off until the job is complete), use extra care not to cut fingers on sharp surfaces.

MAINTENANCE:

A dishwasher air gap may become clogged with leftover food debris escaping the dishwasher filter. The AG300-00X can be cleaned in the event of a clog. To clear a blockage, pull off the decorative cover cap. Remove the top cover by pushing snaps on two sides and pulling the top cover upward. Remove any trapped food particles. After cleaning, snap the top cover back to the body. Install decorative cap cover cap. (See Fig.5)

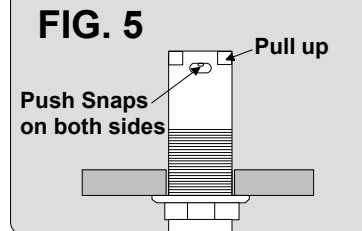
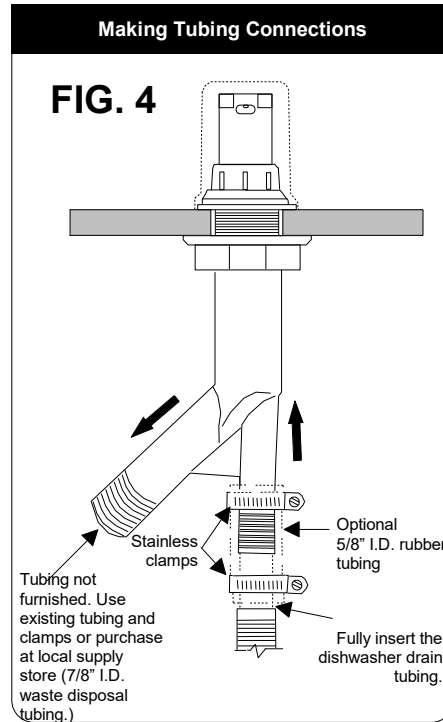

Model:

AG300-008

SINGLE DISHWASHER AIR GAP WITH BRASS DECORATIVE CAP

BLACK COLOR



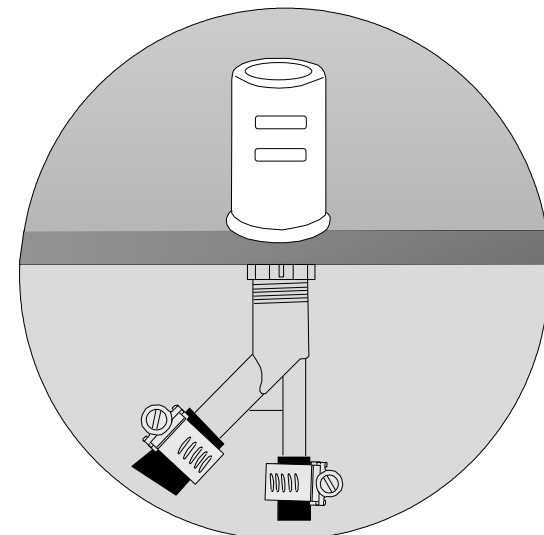

(Maximum flow rate 7.5 GPM)



Installation Procedures

Caution - Do Not Overtighten Nuts or Clamps

LIST OF PARTS ENCLOSED

1 – Main Body			1 – Mounting Washer		
1 – Brass Decorative Cap			1 – Mounting Nut		
			1 – Bottom Nut		

DIFFERENT FINISHES OF BRASS DECORATIVE CAPS AVAILABLE AS BELOW:

AG300-001-Brass Decorative Cap	AG300-003-Stainless Steel	AG300-006-Oil Rubbed Bronze
AG300-002-Chrome Finish	AG300-004-Brushed Nickel	AG300-007-White
	AG300-005-Satin Nickel	AG300-008-Black

A dishwasher air gap is a critical component in maintaining a safe water supply. It prevents contaminants in the sink from flowing into the dishwasher and is required by code in most states.

Please read the instructions once through before starting.

NEW INSTALLATION

1. Unit installation requires a 1-3/8 inch hole in the sink or countertop.

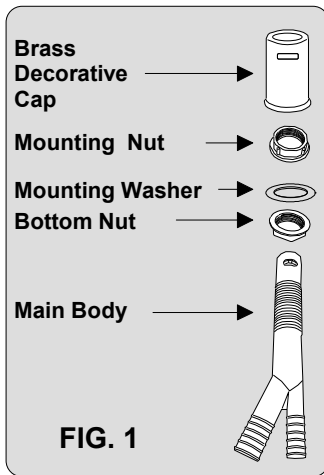

2. Remove decorative cap. Unscrew and remove the mounting nut and mounting washer from the AG300-00X body. Turn the bottom nut counterclockwise further down the air gap's body. Leave sufficient length for the air gap to protrude through the mounting hole. (See Fig. 1)

3. Insert the air gap up through the hole in the sink. Ensure 1/2" of the air gap threads are visible above. Reinstall the mounting washer and nut over the threaded main body of the unit. (See Fig. 2)

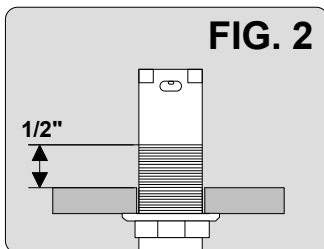

4. Orient the bottom inlet and outlet under the sink as desired. Then, pull down on the air gap while tightening the bottom nut clockwise. **DO NOT OVERTIGHTEN.**

Do not clean decorative housing with any abrasive cleaner. Doing so will void the warranty. To clean, use only soap and water.

CAUTION: (NO TOOLS)
Use hands only above the sink

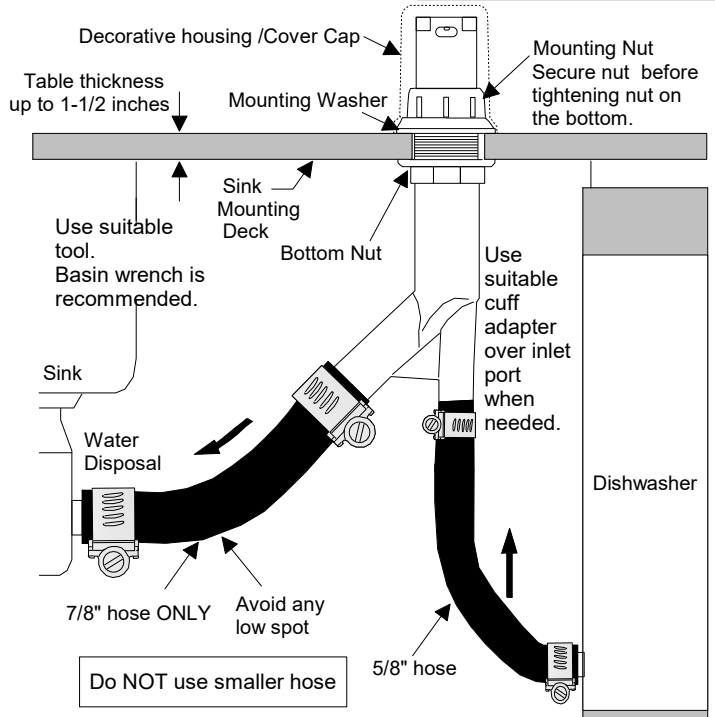

6. Install the decorative cap by pushing it down over the housing to cover the mounting nut and washer. Rotate the decorative cap so the two air gap openings face the sink.

7. Connect the dishwasher drain hoses to the 5/8-inch inlet ports (straight leg of the air gap body) of the AG300-00X with hose clamps. (See Fig. 3)

8. Connect the air gap drain hose to the 7/8-inch outlet port of the AG300-00X with a hose clamp. (See Fig. 3)